

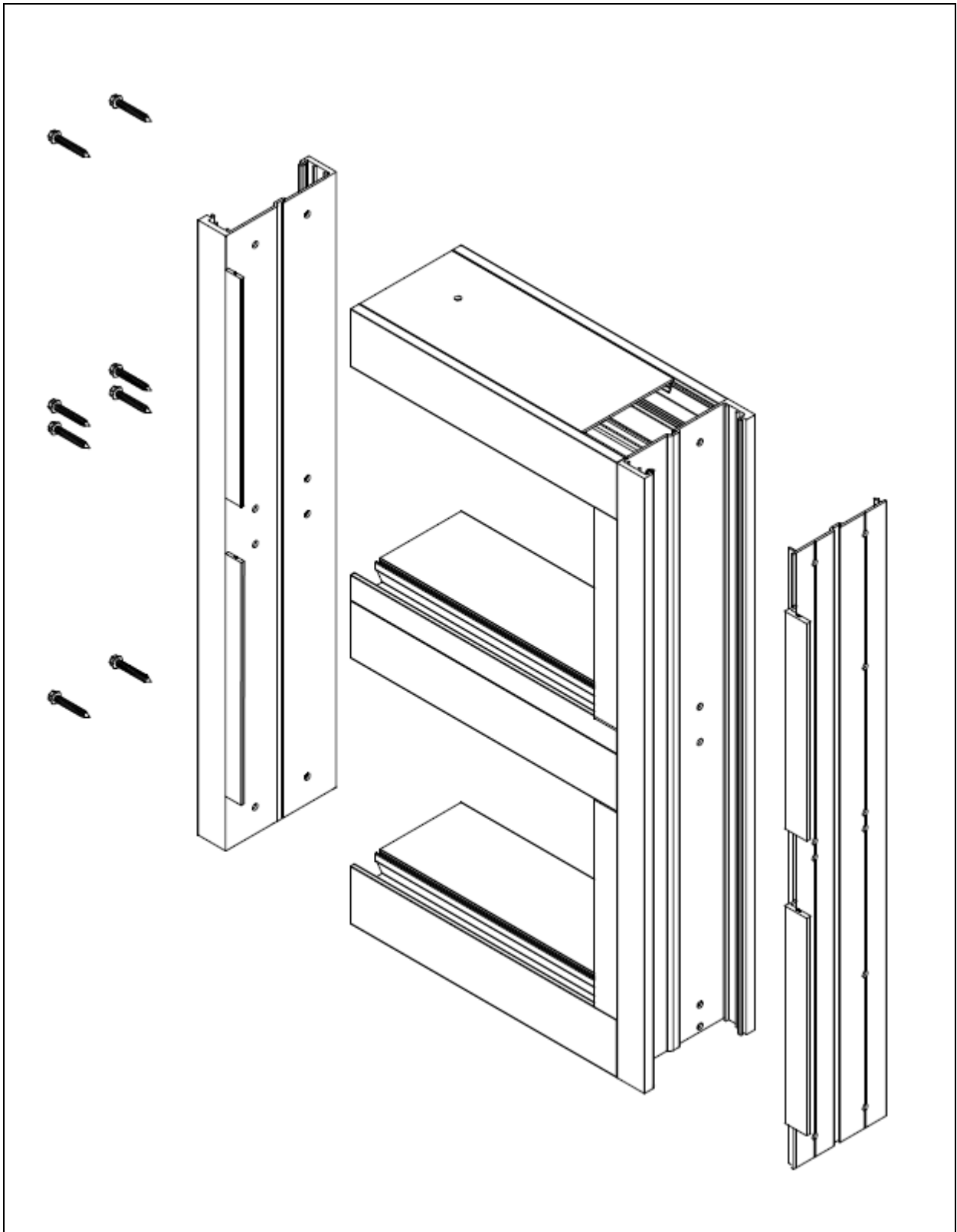











# SlimFront SS3520 Storefront Installation Manual









# Slimfront SS3520 Storefront System

## Extrusion Identification

 <p><b>CGIC-201</b> Head/Sill/Horizontal</p>	 <p><b>CGIC-202</b> Horizontal Pocket Filler</p>
 <p><b>CGIC-206</b> Jamb/Mullion</p>	 <p><b>CGIC-207</b> Vertical Pocket Filler</p>
 <p><b>CGIC-208</b> HD Jamb/ Mullion</p>	 <p><b>CGIC-213</b> HD Mullion Cover</p>
 <p><b>CGIC-204</b> 9/16" Glass Stop</p>	 <p><b>CGIC-205</b> 1-1/4" IG Glass Stop</p>
 <p><b>CGIC-212</b> Door Transom Adapter</p>	 <p><b>CGIC-203</b> Flat Filler Plate</p>
 <p><b>CGIC-214</b> HD Jamb Cover</p>	 <p><b>CGIC-003</b> Flat Filler Plate (Used with Steel Reinforcement)</p>

# Slimfront SS3520 Storefront System

## Hardware Identification

 <p><b>CGIC-006</b> Interior Glazing Gasket</p>	 <p><b>CGIC-007</b> Spacer Gasket</p>
 <p><b>CGIC-010</b> Frame Assembly Screw</p>	 <p><b>CGIC-215</b> Panel to Panel Bolt</p>
 <p><b>CGIC-012</b> Panel to Panel Bolt Nut</p>	 <p><b>CGIC-209</b> Steel Reinforcement</p>

# Slimfront SS3520 Storefront System

---

## Install Frames

- Step 1: Clean all silicone contact surfaces using 2-method cloth with isopropyl alcohol solution
- Step 2: Prior to snapping frames together, run a bead of silicone along length of vertical pocket filler at the exterior as shown in drawing.
- Step3: Position first two frames into opening and snap them together. Engage exterior snap leg of vertical filler first and rotate interior snap leg into vertical mullion as shown.
- Step 4: Install #1/4-20 Flat Head screw bolts with lock nut (provided by CGIC) and washer through mullion and steel at each hole location.
- Step 5: Position next frame into opening and snap into frame assembly as instructed in step 3. Repeat this step until all frames are snapped together to complete frame assembly.
- Note: Frames with door jambs are snapped together the same way as frames with verticals. Smaller elevations may be snapped together and then positioned into opening as single unit.

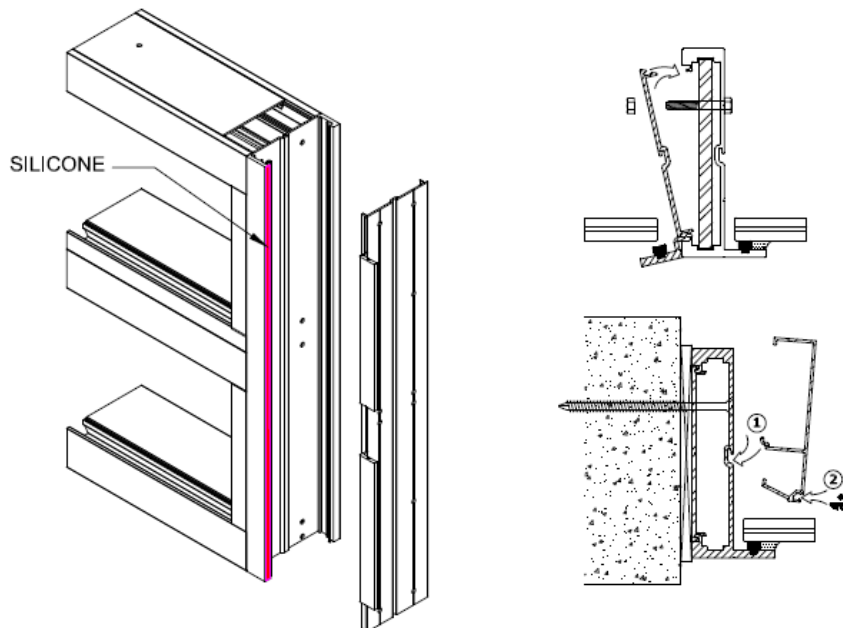

### Apply Exterior Sealant

Step 1: The joint between the vertical and horizontal glazing legs must be sealed to ensure a water tight joint. Apply the tool sealant to all vertical and horizontal glazing leg joints and extend it to the glazing tape as shown.

